

# ALUSAPE

FERRAGENS EM ALUMÍNIO

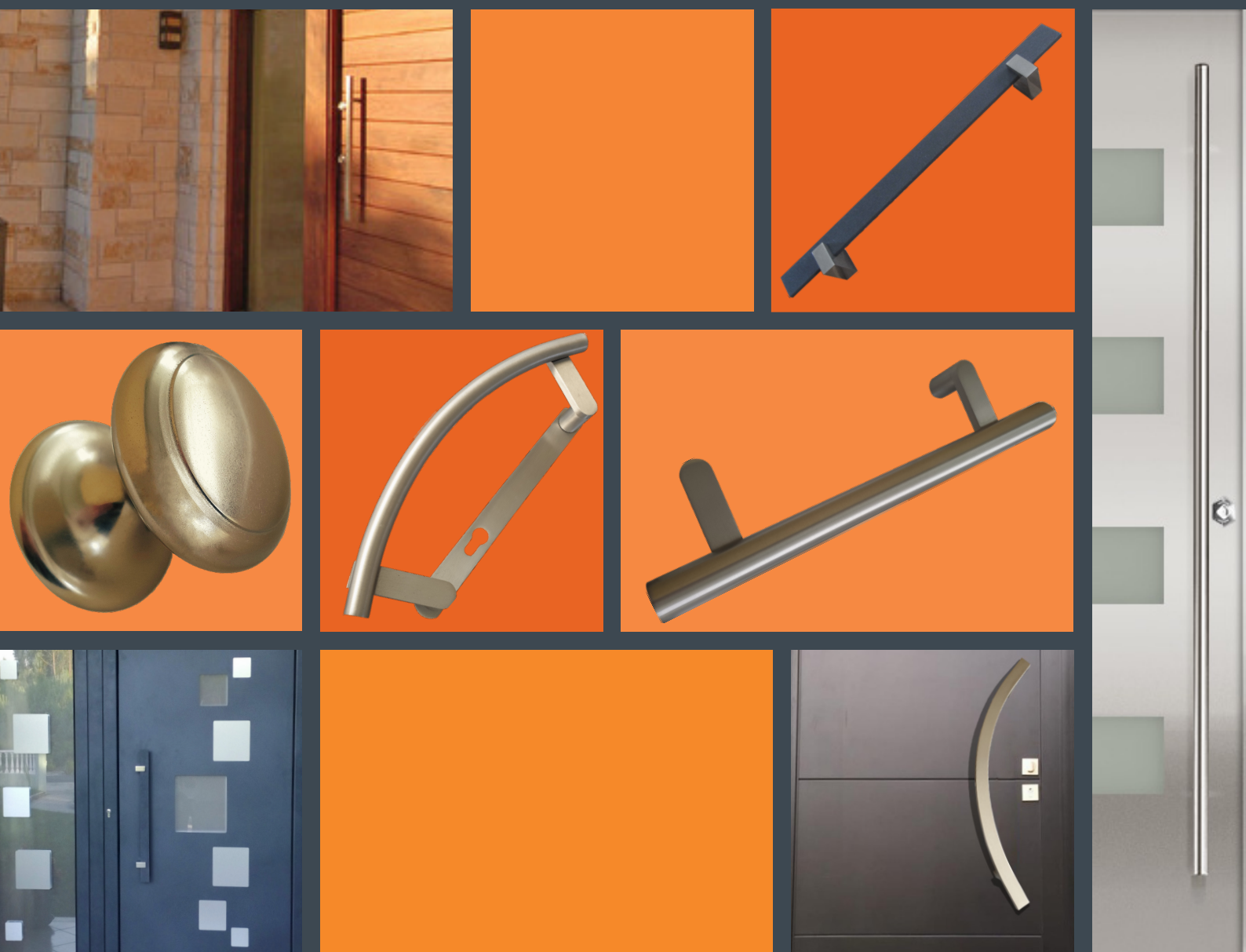

## CATÁLOGO DE PRODUTOS

[WWW.ALUSAPE.PT](http://WWW.ALUSAPE.PT)



REF: 953x19x265mm



REF: 954x320mm



REF: 955x19X265mm

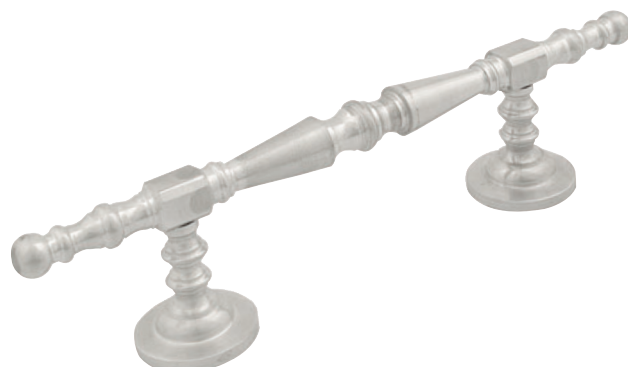

REF: 956x280mm



REF: 957x19x300mm



REF: 957x25x300mm

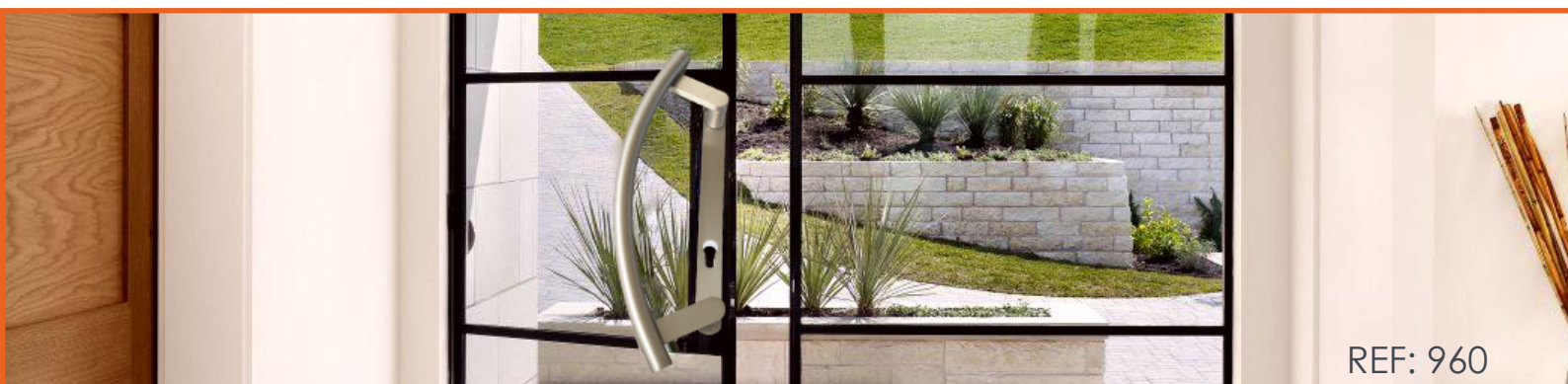
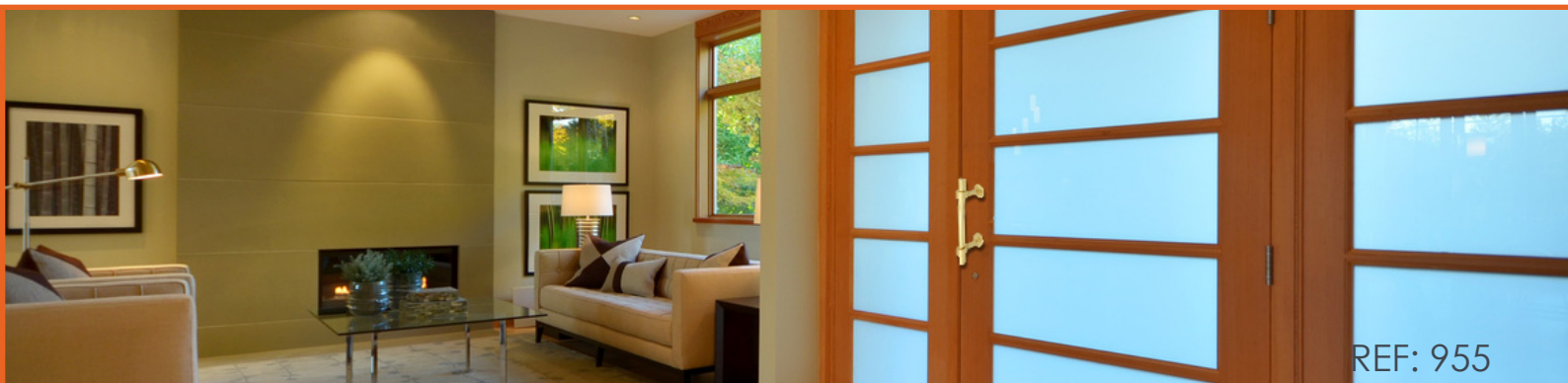



REF: 958x19x340mm



REF: 959x19x380mm



REF: 960x22x400mm



REF: 959/1x19x400mm



REF: 961x30x400mm  
Acabamento Alunox



REF: 961  
Acabamento Alunox



REF: 962x30x16x300mm  
(com pés normais)

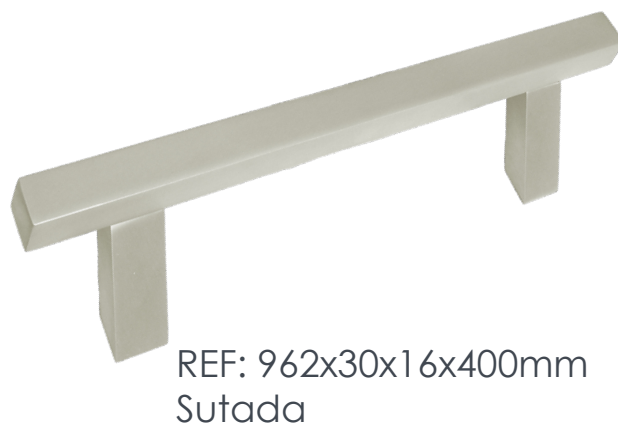

REF: 962x30x16x400mm  
Sutada

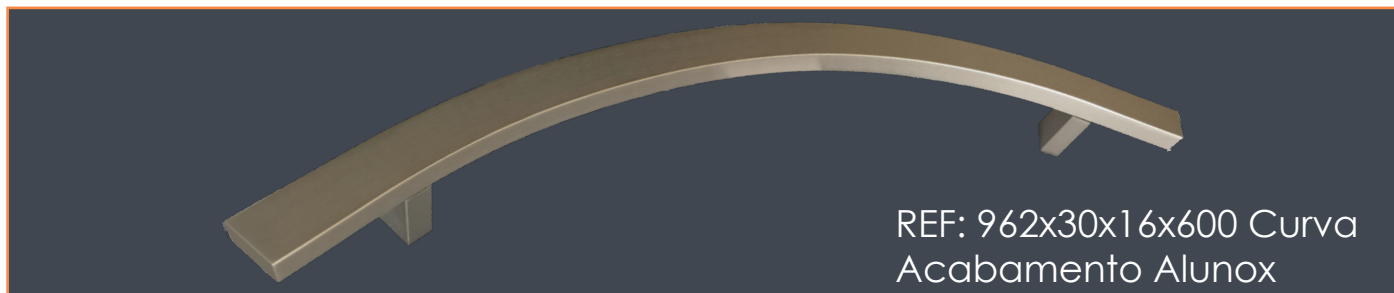

REF: 962x40x20mm  
(com pés nas pontas)



REF: 964x30x400mm  
Curva "Facetada"

REF: 963x30x400mm



REF: 962x40x20mm  
"Facetada"

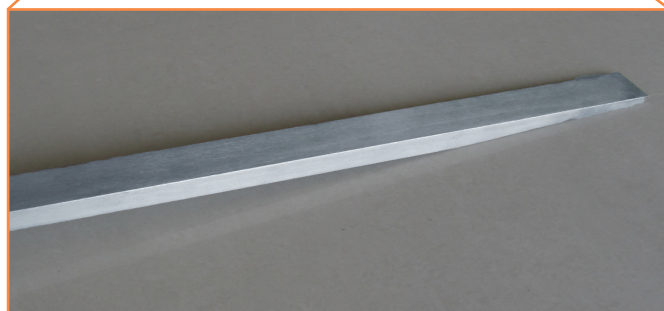

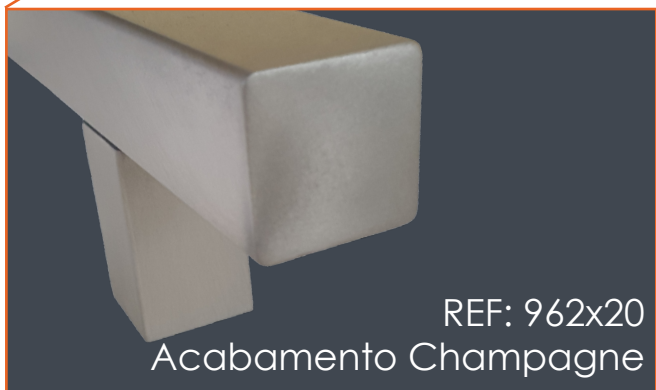



REF: 966x40x8x500mm

966  
SABLÉ





REF: 954

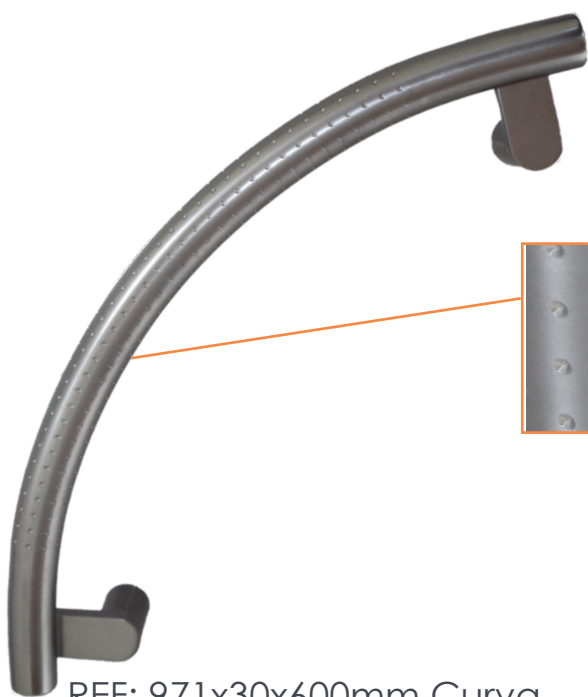

REF: 971x30x600mm Curva  
"Picada"

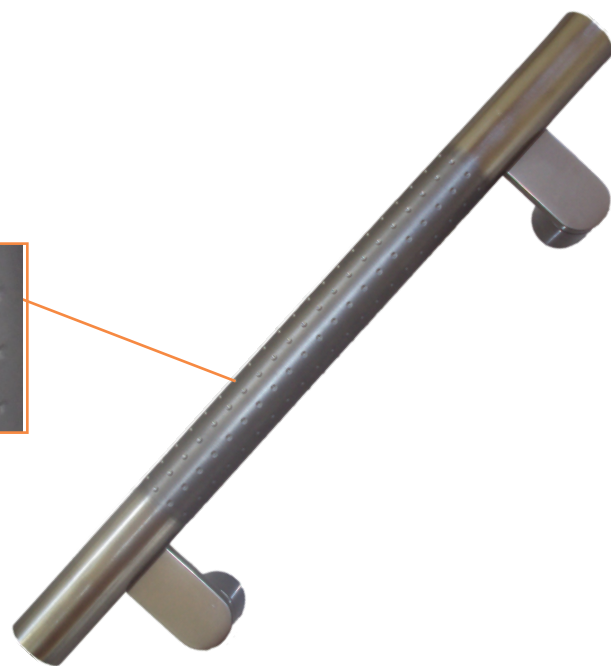

REF: 974x30x400mm "Picada"





REF: H



REF: V



REF: W

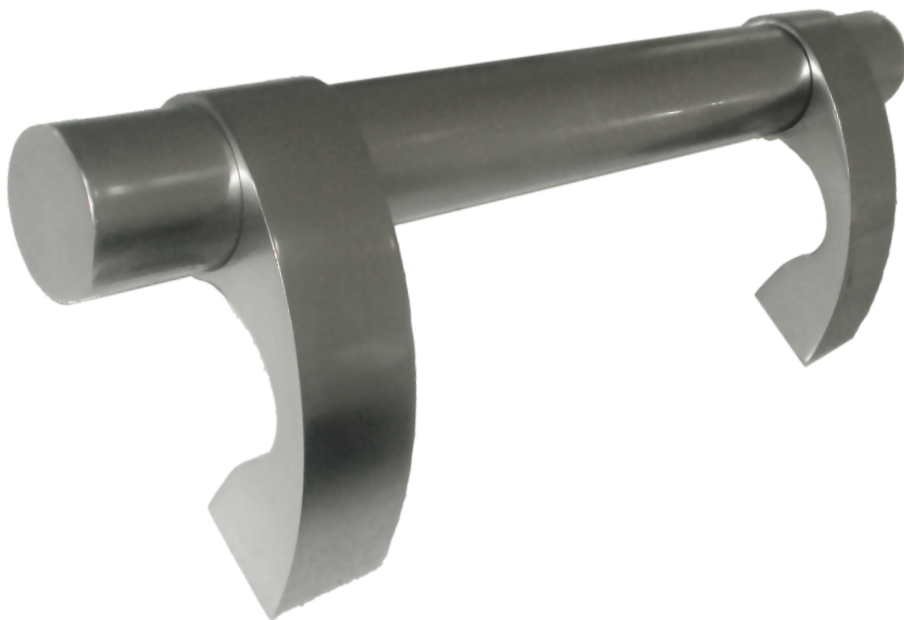

REF: 973x40x600mm

*BATENTE*



REF: 980x170

# PUXADORES



REF: 900x75mm



REF: 901x75mm



REF: 902x45mm



REF: 967

## ACESSÓRIO



Anilha de  
Nylon



Haste e  
Cabeça de  
Inox

# OUTRAS MEDIDAS

REF.	DIÂMETRO Ø (MM)	REF.	DIÂMETRO Ø (MM)	
900	75	957	40x600	
			40x800	
901	75		40x1000	
			40x1200	
902	45		40x1500	
953	19x265			
954	320		958	19x340
			959	19x380
			959/1	19x400
			960 YALL	22x400
955	19x265	961	30x400 SUTADA	
	19x400		30x500 SUTADA	
956	280		30x600 SUTADA	
957	19x300		30x800 SUTADA	
	19x400		30x1000 SUTADA	
	25x300		30x1200 SUTADA	
	25x400	30x1500 SUTADA		
	25x500			
	25x600	20x20x300		
	25x800	20x20x400		
	25x1000	20x20x500		
	30x300	30x16x300		
	30x400	30x16x400		
	30x500	30x16x500		
	30x600	30x16x600		
	30x800	30x16x800		
	30x1000	30x16x1000		
	30x1200	30x20x1200		
	30x1400	30x20x1400		
	30x1500	30x20x1500		
30x2000	40x20x400			
	40x20x500			
	40x20x600			
		962		



TEL/FAX: 234698425

MOVEL: 963195663 (FERNANDO SANTOS PEREIRA)

MAIL: ALUSAPE@GMAIL.COM

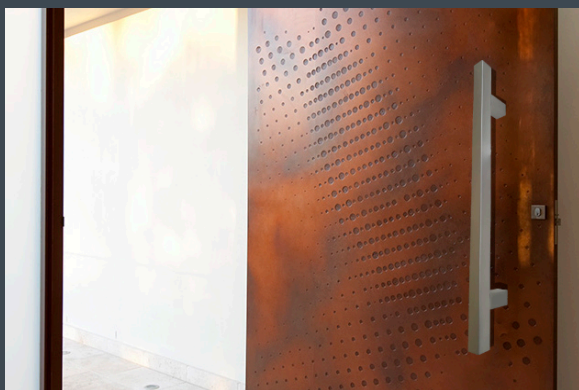

*NOVO*  
**ACABAMENTO**  
ALUNOX

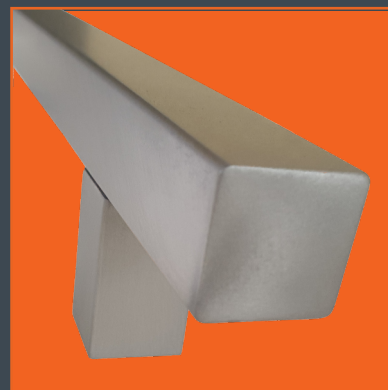

*ACABAMENTOS*  
ANODIZADOS  
LACADOS

*ALUSAPE*  
FABRICO DE FERRAGENS

CATÁLOGO 2022

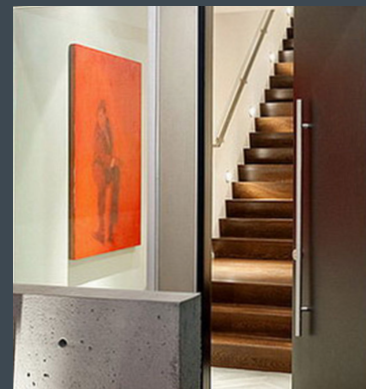
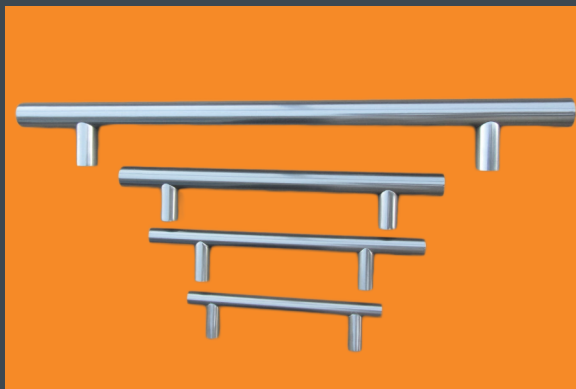

MORADA: RUA DA EIRA, n.º 88, ALHANDRA | 3750-302 ÁGUEDA, PORTUGAL

[WWW.ALUSAPE.PT](http://WWW.ALUSAPE.PT)