

ALUSAPE

FERRAGENS EM ALUMÍNIO

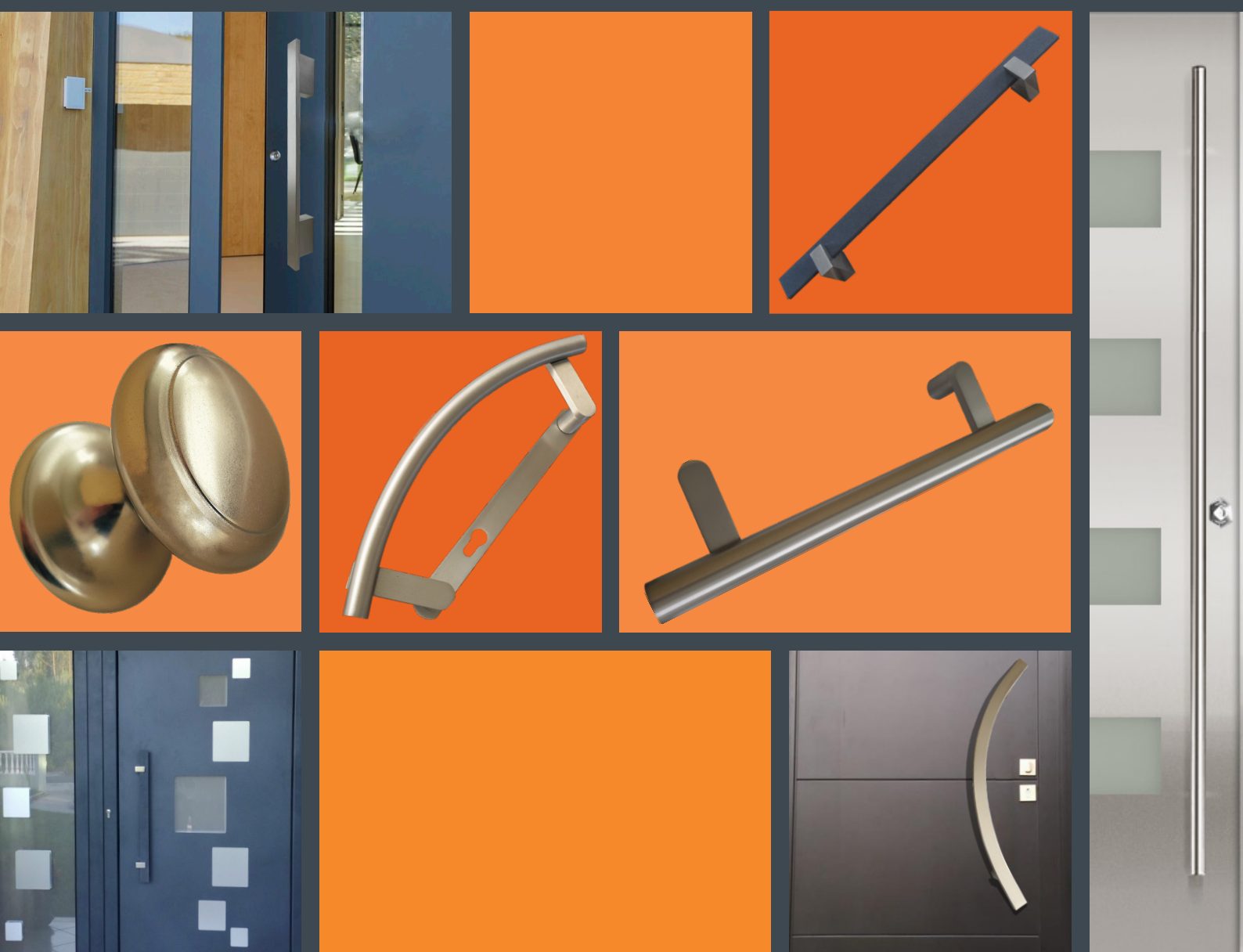

CATÁLOGO DE PRODUTOS

WWW.ALUSAPE.PT



REF: 953x19x265mm



REF: 954x320mm



REF: 955x19X265mm



REF: 956x280mm



REF: 957x19x300mm



REF: 957x25x300mm



REF: 962 (várias medidas)



REF: 957

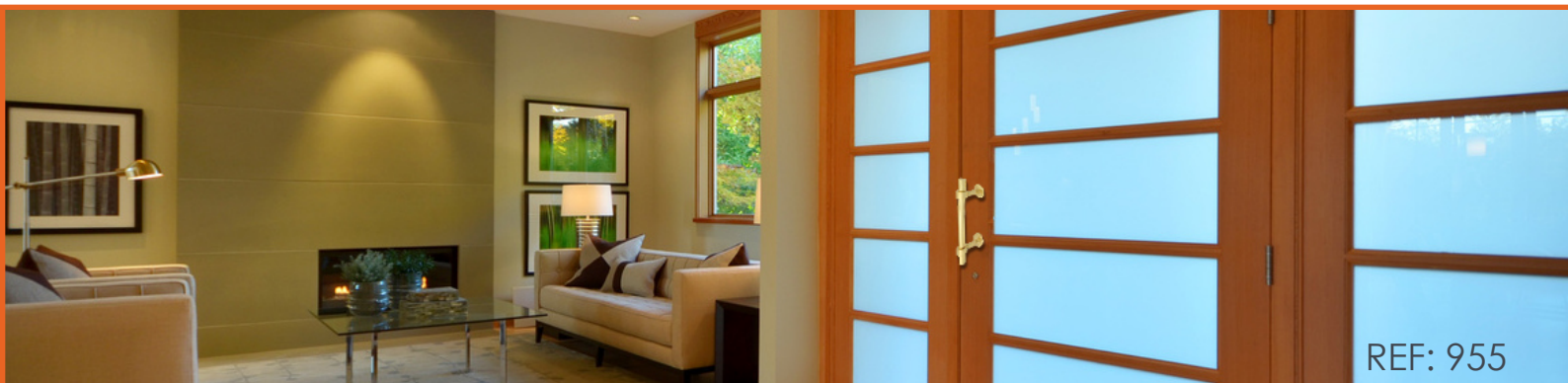

REF: 955

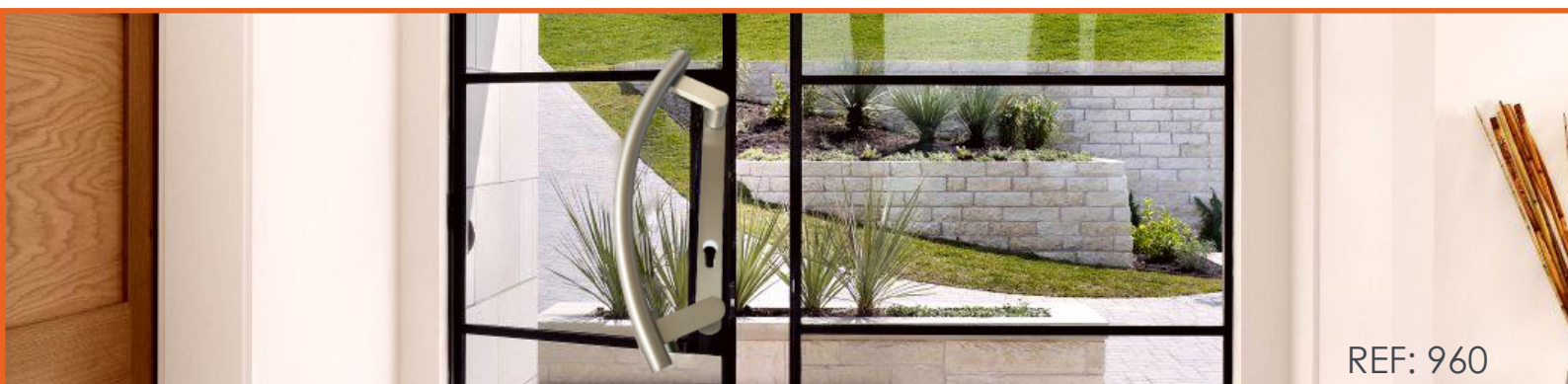

REF: 960



REF: 958x19x340mm



REF: 959x19x380mm



REF: 960x22x400mm



REF: 959/1x19x400mm



REF: 961x30x400mm
Acabamento Alunox



REF: 961
Acabamento Alunox



REF: 962x30x16x300mm
(com pés normais)



REF: 962x30x16x400mm
Sutada

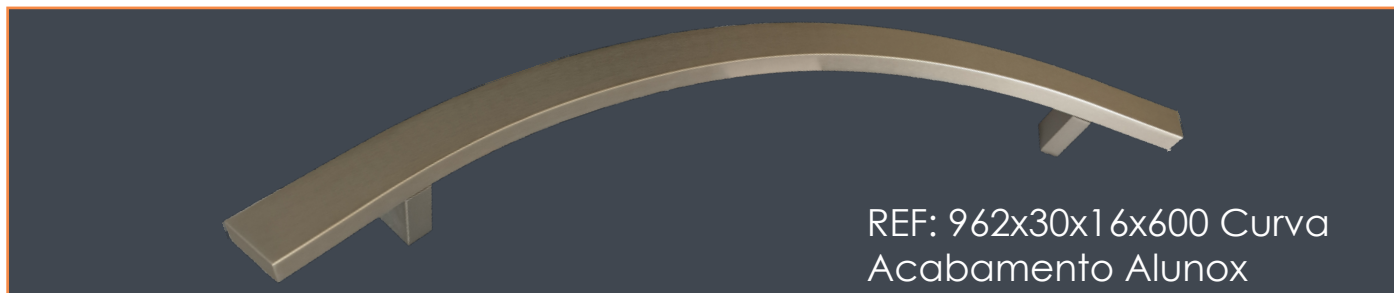

REF: 962x40x20mm
(com pés nas pontas)



REF: 964x30x400mm
Curva "Facetada"

REF: 963x30x400mm



REF:
962x40x20mm
"Facetada"

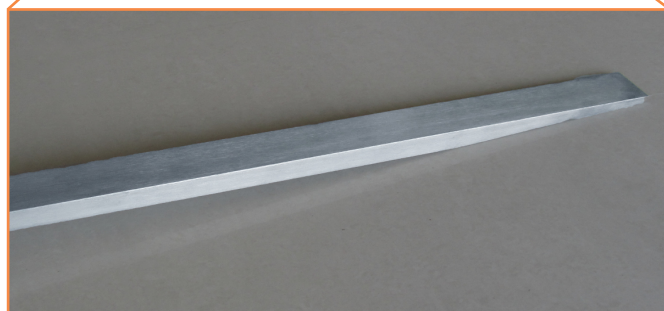

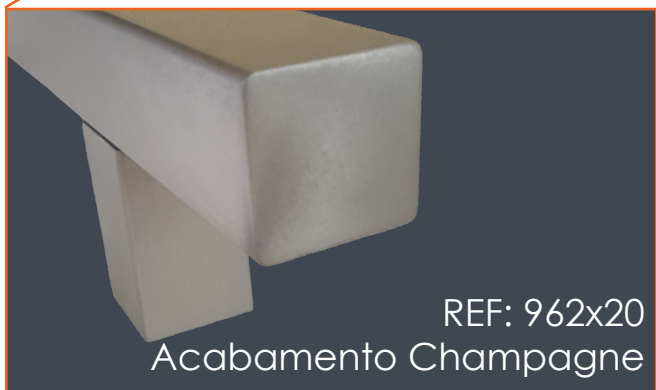



REF: 966x40x8x500mm

966
SABLÉ



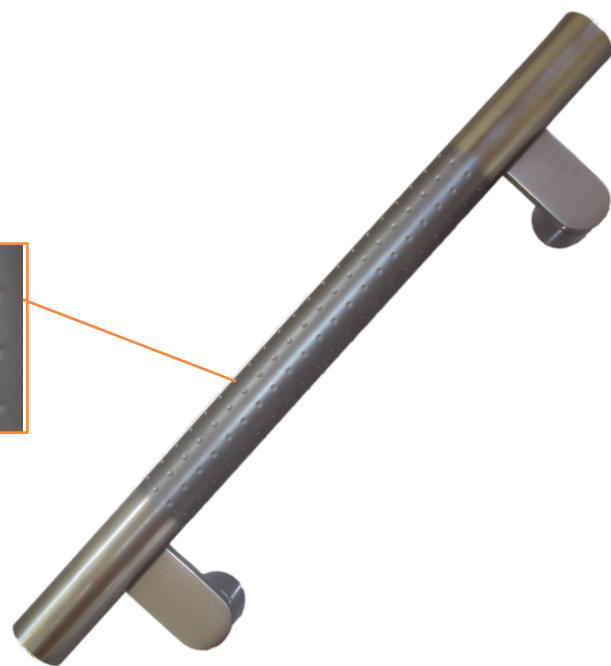
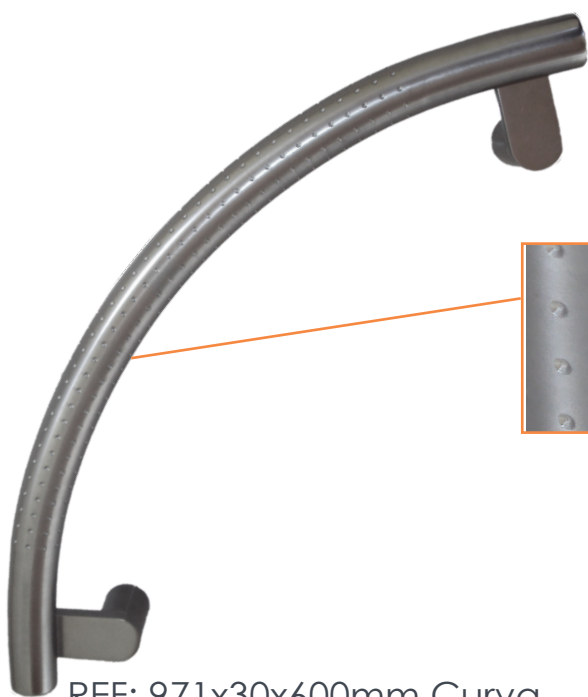



REF: H



REF: V



REF: W

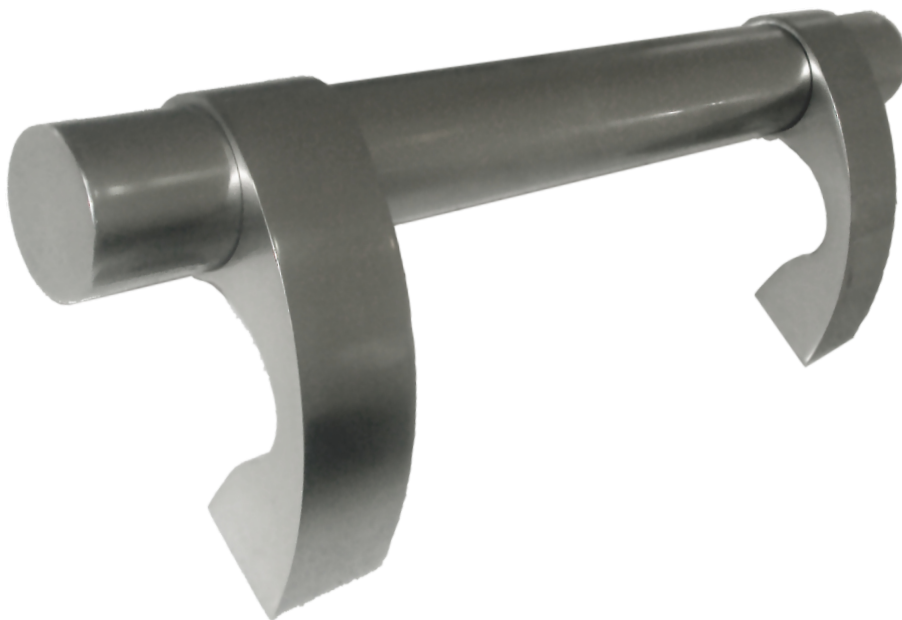

REF: 973x40x600mm

BATENTE



REF: 980x170

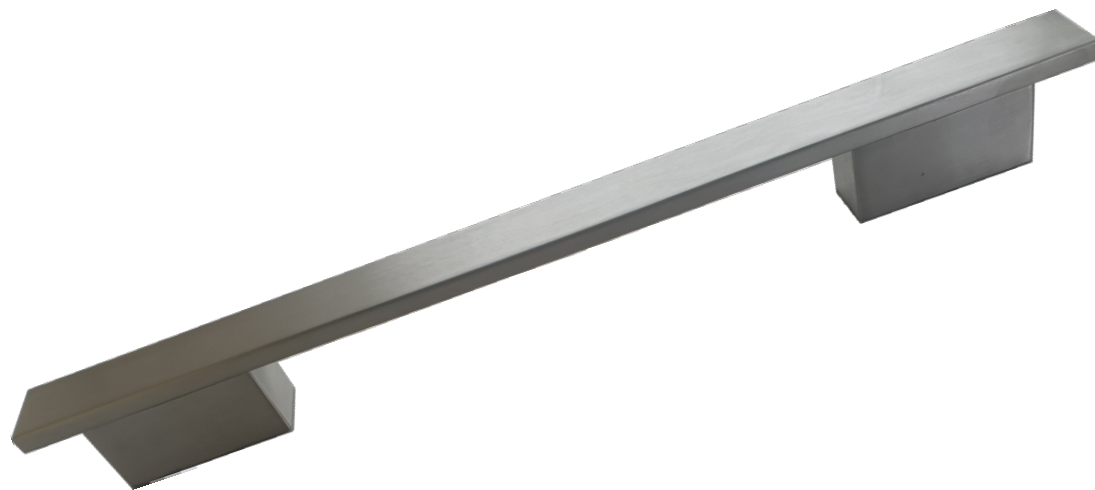

REF: 978x45x12

9
7
8



REF: 978x45x12
(600mm até 1600mm)



REF: 978x45x12
Com pés nas pontas



REF: 978x45x12 "Sutada"
(600mm até 1600mm)

PUXADORES



REF: 900x75mm



REF: 901x75mm



REF: 902x45mm



REF: 967

ACESSÓRIO



M8x25x70

M8x30x70



OUTRAS MEDIDAS

REF.	DIÂMETRO Ø (MM)	REF.	DIÂMETRO Ø (MM)	
900	75	957	40x600	
			40x800	
901	75		40x1000	
			40x1200	
902	45		40x1500	
953	19x265			
954	320		958	19x340
			959	19x380
			959/1	19x400
			960 YALL	22x400
955	19x265		961	30x400 SUTADA
	19x400			30x500 SUTADA
956	280	30x600 SUTADA		
957	19x300	30x800 SUTADA		
	19x400	30x1000 SUTADA		
	25x300	30x1200 SUTADA		
	25x400	30x1500 SUTADA		
	25x500			
	25x600	20x20x300		
	25x800	20x20x400		
	25x1000	20x20x500		
	30x300	30x16x300		
	30x400	30x16x400		
	30x500	30x16x500		
	30x600	30x16x600		
	30x800	30x16x800		
	30x1000	30x16x1000		
	30x1200	30x20x1200		
	30x1400	30x20x1400		
	30x1500	30x20x1500		
	30x2000	40x20x400		
	40x20x500			
	40x20x600			

REF.	DIÂMETRO Ø (MM)	REF.	DIÂMETRO Ø (MM)
962	40x20x800	V	30x350
	40x20x1000		
	40x20x1200	W	30x300
	40x20x1400		30x400
	40x20x1500		30x500
963	30x400 CURVA		30x600
	30x600 CURVA		
	30x800 CURVA		
	30x1000 CURVA		
964	30x400		
	30x600		
966	40x8x500		
	40x8x800		
967	19x340		
	22x400		
971	30x600		
973	40x600		
	40x800		
	40x1000		
	40x1500		
974	30x400		
	30x600		
978	45x12x600		
	45x12x800		
	45x12x1000		
	45x12x1200		
	45x12x1400		
	45x12x1500		
	45x12x1600		
980	170		

TEL/FAX: 234698425

MOVEL: 963195663 (FERNANDO SANTOS PEREIRA)

MAIL: ALUSAPE@GMAIL.COM

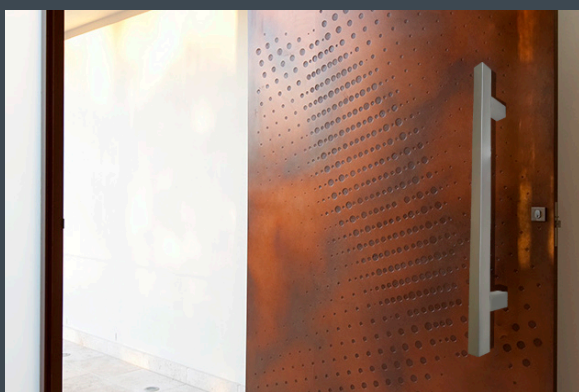

NOVO
ACABAMENTO
ALUNOX

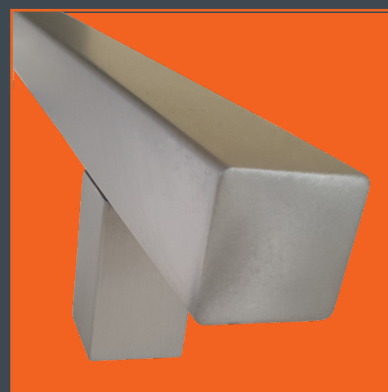

ACABAMENTOS
ANODIZADOS
LACADOS

ALUSAPE
FABRICO DE FERRAGENS

CATÁLOGO 2023



MORADA: RUA DA EIRA, n.º 88, ALHANDRA | 3750-302 ÁGUEDA, PORTUGAL

WWW.ALUSAPE.PT